

HYUNDAI
POWER PRODUCTS

PETROL INVERTER GENERATOR HY3500Ei

User Manual

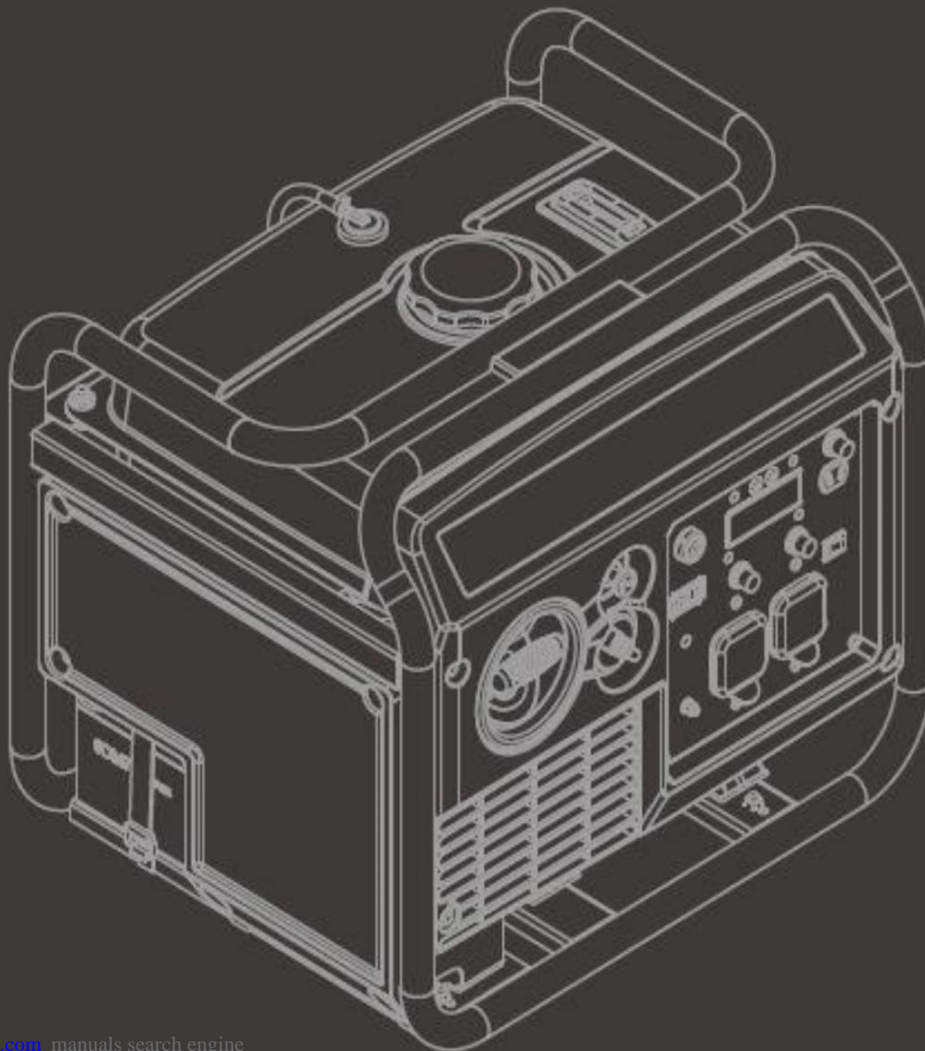

INDEX

	CONTENTS	PAGE NO.S
1	SAFETY	3 - 8
2	PART LOCATIONS	9
3	PRE-ASSEMBLY CHECKS	10 - 11
4	STARTING PROCEDURE	12
5	STOPPING PROCEDURE	13
6	OPERATING INSTRUCTIONS	13 - 16
7	MAINTENANCE	17 - 19
8	TRANSPORT & STORAGE	20
9	TROUBLESHOOTING	21
10	SPECIFICATION	22
11	RECYCLING & PRODUCT DISPOSAL	23
12	DECLARATION OF CONFORMITY	24
13	CONTACT DETAILS	25
14	MANUAL UPDATES	25
15	WARRANTY	25

1. SAFETY

1.1 General Safety Notes.

- 1.2 The operator of the machine is responsible for, and has a duty of care in making sure that the machine is operated safely and in accordance with the instructions in this user manual. Keep the manual safe and pass it on if the machine is loaned or sold to another user.
- 1.3 Please note the following safety points.
- 1.4 The machine should never be left in a condition which would allow an untrained or unauthorised person/s to operate this machine.
- 1.5 All due care and diligence should be taken by the operator for the safety of and with regard to those around whilst using the machine.
- 1.6 Some or all of the following - warning signs, symbols and/or PPE pictograms may appear throughout this manual. You **MUST** adhere to their warnings. Failure to do so may result in personal injury to yourself or those around you.



DANGER

Indicates a hazard, which, if not avoided, could result in serious injury or death.



WARNING

Indicates a hazard, which, if not avoided, could result in serious injury.



CAUTION

Indicates a hazard which, if not avoided, might result in minor or moderate injury.



NOTE

Indicates a situation that could easily result in equipment damage.

- 1.7 READ and keep the manual safe and pass it on if the machine is loaned or sold to another user.
- 1.8 You **MUST** fully understand all instructions to ensure you use and operate the machine safely.
- 1.9 Appropriate Personal Protective Equipment (PPE), **MUST** be worn at all times when operating or repairing the machine.



HAND PROTECTION MUST BE WORN



EYE PROTECTION MUST BE WORN



PROTECTIVE CLOTHING MUST BE WORN



HEARING PROTECTION MUST BE WORN



FOOT PROTECTION MUST BE WORN



HEAD PROTECTION MUST BE WORN



RESPIRATOR MUST BE WORN



FACE SHIELD MUST BE WORN

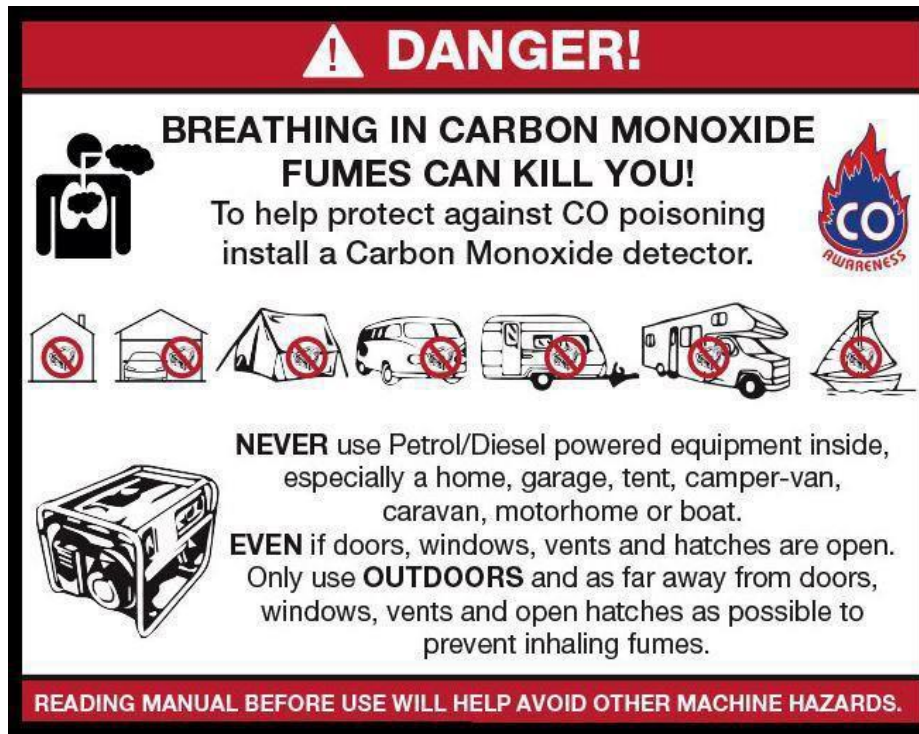

- 1.11 Carbon monoxide is a colourless and odourless gas. Inhaling this gas can cause death as well as serious long term health problems such as brain damage.
- 1.12 The symptoms of carbon monoxide poisoning can include but are not limited to the following;
Headaches, dizziness, nausea, breathlessness, collapsing or loss of consciousness.
- 1.13 Carbon monoxide poisoning symptoms are similar to flue, food poisoning, viral infections and simply tiredness. It is quite common for people to mistake this very dangerous poisoning for something else.
- 1.14 To avoid carbon monoxide poisoning **DO NOT** use Petrol/Diesel powered equipment inside any of the following; Home, garage, tent, camper van, mobile home, caravan or boat. This is not exhaustive and if you are in any doubt contact your dealer.
- 1.15 If you think you have or someone around you has been affected by carbon monoxide poisoning;
- 1.16 Get them fresh air immediately, by leaving the affected area or by opening doors and windows. If safe and practical to do so make sure that the machine is turned off.
DO NOT enter a room you suspect of having carbon monoxide present – instead call the emergency services.
- 1.17 Contact a Doctor immediately or go to Hospital – let them know that you suspect carbon monoxide poisoning.
- 1.18 **DO NOT** use in an enclosed area or moving vehicle.

1.20 **General Fuel Safety (where applicable).**



CAUTION

ALL FUELS ARE FLAMABLE

1.21 Fire Hazard – keep fuel away from all sources of ignition for example heaters. Lamps, sparks from grinding or welding.



1.22 **DO NOT** carry out hot work on tanks that have contained fuel.

1.23 **ALWAYS** keep the work area tidy.

1.24 **ALWAYS** clean up spills promptly using absorbent granules and a lidded bin.

1.25 **ALWAYS** dispose of waste fuels correctly.

1.30 **Fueling/De-fueling (where applicable).**



CAUTION

ALL FUELS ARE FLAMABLE

1.31 **ALWAYS** fuel and defuel in a well ventilated area outside of buildings.

1.32 **ALWAYS** wear correct, suitable and fit for purpose Personal Protective Equipment (PPE), suggested items are but not limited to safety gloves, overalls.



1.33 When fueling/de-fueling **ALWAYS** avoid inhaling fumes.

1.34 When de-fueling **ALWAYS** use a proper fuel retriever.



1.35 **ALWAYS** carry fuel in the correct and clearly marked container.

1.40 **Electrical Safety (where applicable).**

1.41 Electricity can kill – **NEVER** work on **LIVE/ENERGISED** equipment.

1.42 Prior to carrying out any maintenance work you **MUST** identify electrical isolation methods and isolate all electrical supplies.

1.43 Prior to use and with all electrical supplies isolated, you **MUST** check all electrical cables, plugs and connectors for the following;

1.44 Are intact and have no signs of damage, to include but not limited to bare wires, chaffing, cuts and loose wiring.

1.45 If there are any signs of damage, the damage item **MUST** be taken out of service until the damage has been repaired by an electrically competent person.

1.46 All trailing cables should be routed so as not to cause any kind of triphazard.

1.47 **NEVER** work on or near electricity with wet hands, wet clothing and wetgloves.



1.50 Batteries (where present).

1.51 Batteries present a risk if they become damaged by the possible leaking of electrolyte. This electrolyte is an acid and can cause serious burn injuries. Care should be taken when working on or near them. **NOTE** the electrolyte may be in a liquid or gel form.

1.52 Should you come in to contact with electrolyte you should;

1.53 Remove all clothing contaminated with electrolyte. If you cannot remove then saturate them in water.

1.54 Get medical assistance as soon as possible. You must advise the medical staff of the type of acid.

1.55 Lead/acid battery = dilute sulphuric acid.

1.56 Nickel/cadmium = potassium hydroxide alkali electrolyte.

1.57 Use fresh running water to wash off excess electrolyte, continue this until medical assistance arrives. Make sure that you do not wash the electrolyte to another part of your body or face.

1.58 If electrolyte comes in to contact with Eyes the electrolyte needs to be immediately washed away with large amounts of water. Make sure that you do not wash the electrolyte to another part of your face or body.

1.59 Gasses from charging batteries are highly flammable and great care should be taken to charge in well ventilated areas.

1.59.1  There is an explosion risk if the battery terminals are short circuited, when connecting/disconnecting **ALWAYS** exercise great care so that the terminals or battery leads are **NOT** allowed to touch and cause a spark. **ALWAYS** use suitable insulated tools.

1.60 Vibrations (where applicable).

1.61 Prolonged use of hand held (operated) machines will cause the user to feel the effects of/from vibrations. These vibrations can lead to white finger (Raynaud's phenomenon) or carpal tunnel syndrome. This condition reduces the ability of the hand to feel and regulate temperature, causing numbness and heat sensations and may cause nerve damage and circulatory tissue death.

1.62 Not all factors that lead to white finger disease are known, but cold weather, smoking and other diseases that affect blood vessels and blood circulation as well as large and long-lasting impact of shocks are considered factors in the formation of white finger. Note the following to reduce the risk of white finger and carpal tunnel syndrome;

1.63 Wear gloves and keep your hands warm.

1.64 Take regular breaks.

1.65 All of the above precautions may help reduce the risk of white finger disease but not rule out the carpal tunnel syndrome. Long-term and regular users are therefore recommended to observe the condition of your hands and fingers. Seek medical attention immediately if any of the above symptoms should occur.

1.70 Noise (where applicable).

1.71 The operating noise of the machine can damage your hearing. Wear hearing protection such as earplugs or ear defenders to protect your hearing. Long-term and regular users are advised to have hearing checked regularly. Be especially vigilant and cautious when hearing ear protection because your ability to hear alarm warnings will be reduced.

1.72 Noise emissions for this equipment is unavoidable. Carry out noisy work at approved times and for certain periods. Limit the working time to a minimum. For your personal protection and protection of people working nearby it is also advisable for them to wear hearing protection.



1.73 See Certificate of Conformity section for Outdoor Noise declaration of conformity.

MACHINE SPECIFIC SAFETY

1.80 General Machine Safety.

1.81 Read the owner's manual carefully to understand how to operate this machine properly.

1.82 You should **NEVER** use the machine when;

1.83 Wearing loose clothing, barefoot or sandals.

1.84 Under the influence of drink or drugs or as a result of having taken medication for cold or flu, or any other times when a possibility exists that your judgement might be impaired or that you might not be able to operate the machine properly and in a safe manner.

1.85 Suffering from exhaustion or lack of sleep.

1.86 When the ground is slippery or when other conditions exist which might make it not possible to maintain a steady posture.

1.87 At night, at times of heavy fog, or at any other times when your field of vision might be limited and it would be difficult to gain a clear view of the area.

1.88 During rain storms, lightning storms, at times of strong or gale force winds, or at any other times when the weather conditions might make it unsafe to use this product.

1.89 **NEVER** run the engine indoors. The exhaust gasses contain harmful carbon monoxide.

1.90 When using this machine for the first time and before actual work, you **MUST** learn how to handle the machine from an experienced or skilled person.

- 1.91 **NEVER** allow children or anyone unable to fully understand the directions given in this manual to operate this product.
- 1.92 Make sure you keep this manual handy so you may refer to it whenever questions arise and ensure you pass this manual on if the machine is loaned or sold.
- 1.93 Correct Personal Protective Equipment (PPE) **MUST** be worn at all times when operating or repairing this machine. This should include but is not limited to;



- 1.94 **DO NOT** use this machine inside a confined space such as but not limited to a vehicle, house, garage, container, boat or building. Only use outside in a well ventilated area.
- 1.95 For air cooling a minimum of 1 meter is required all around the machine.
- 1.96 Maximum ambient temperature 40 degrees Celsius.
- 1.97 Fire risk- Fuel can expand and overflow in a hot environment or moving vehicle.
- 1.98 Explosion risk- LPG/ Petrol can leak and the vapour are heavier than air. Never store in confined spaces especially in a boat where the vapour will accumulate in the hull and create a high risk of explosion.
- 1.98.1 Carbon monoxide poisoning risk- Never run an engine in a confined space or poorly ventilated area. Keep the machine away from windows to prevent fumes entering the internal space. Carbon monoxide is produced by the engine and contained in the exhaust fumes. You cannot see it or smell it and it can kill you in minutes.
- 1.98.2 Never use inside a confined space with an exhaust extension. If the exhaust extension fails the escaping exhaust gases could kill you.

2. PART LOCATIONS

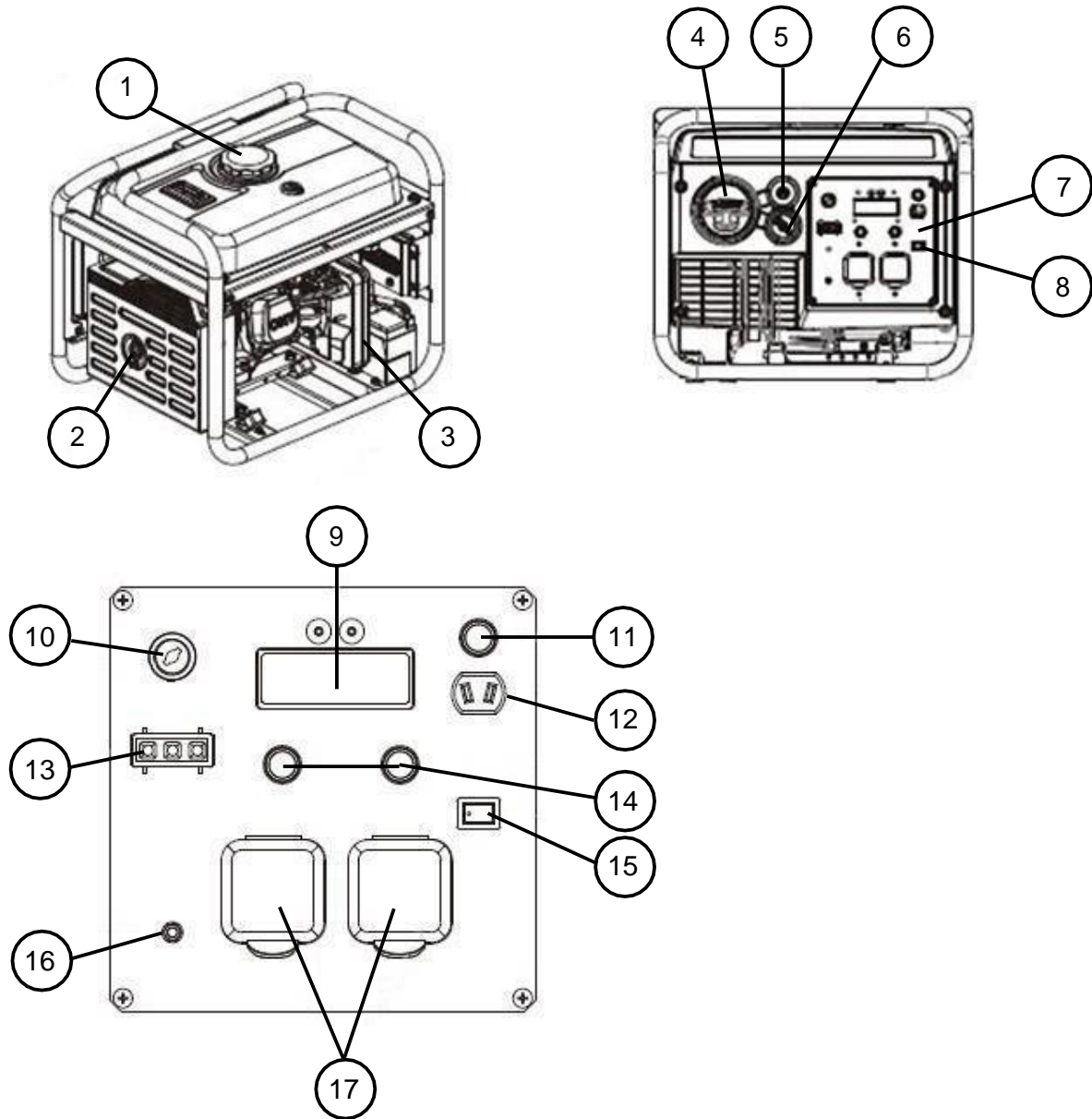

1	Fuel Filler Cap	10	Ignition Switch
2	Exhaust	11	DC Protector
3	Air Filter	12	DC Socket
4	Recoil Starter Handle	13	Indicator Lights
5	Choke	14	AC Circuit Breakers
6	Fuel Switch	15	Economy Switch
7	Control Panel	16	Earth Point
8	Economy Switch	17	AC Sockets
9	LCD Display		

3. PRE OPERATION CHECKS



WARNING

This machine is shipped without fuel and oil and **MUST** be filled before operation. Failure to do so may result in engine damage the will not be covered by Warranty. Ensure the generator is on flat, level ground before filling with fuel or oil.



WARNING

ALL FUELS ARE FLAMMABLE

Switch off the engine and allow to cool before filling with fuel and **ALWAYS** fuel and defuel in a well ventilated area.

DO NOT MIX FUEL WITH OIL.

FUEL TYPE	Unleaded Petrol
FUEL TANK CAPACITY	12.5 Litres
ENGINE OIL TYPE	Semi-Synthetic SAE 15W40
ENGINE OIL CAPACITY	600ml

- 2.0 Place the generator on a flat, level surface.
- 2.1 Remove the oil filler cap/dipstick (1).
- 2.2 Slowly fill with 600ml of semi-synthetic SAE 15W40 engine oil. Stop occasionally to check the level.
- 2.3 Fill to the upper limit on the oil filler neck (2).

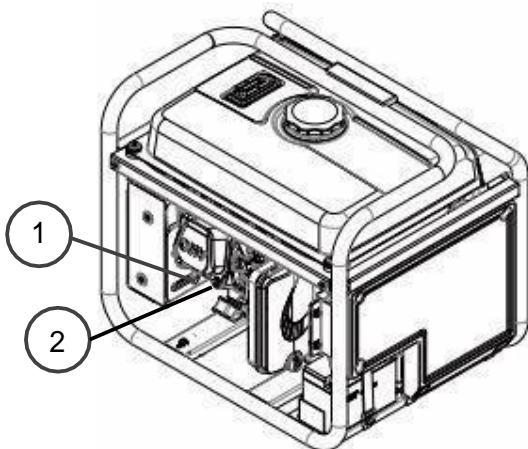

Engine Oil
Capacity:
600ml

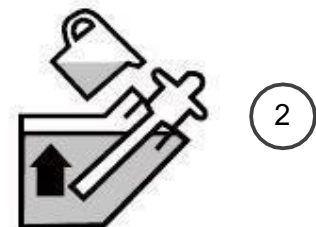

- 2.4 If you overfill with oil, you can drain the excess by removing the oil drain plug (3).
- 2.5 Once the correct oil level has been reached. Refit the oil filler cap/dipstick securely.

- 2.6 To fill with fuel, remove the fuel filler cap.
- 2.7 Fill with 12.5 litres of fresh unleaded petrol.
DO NOT mix fuel with the oil.
- 2.8 **DO NOT** overfill, fill to the upper limit mark or leave a 25mm gap between the fuel and the top of the fuel tank.

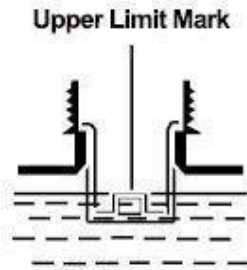

- 2.9 Wipe up any spills immediately.
- 2.10 Refit the fuel filler cap securely.
- 2.11 This generator is supplied with a 'floating earth'.
- 2.12 It is therefore extremely important that you only use the generator to power equipment in the following permutations;
 - 1 or more class 2 equipment or;
 - 1 piece of class 1 equipment or;
 - 1 or more Class 2 equipment and 1 piece of Class 1 equipment.
- 2.13 Class 1 equipment uses an earth wire.
- 2.14 Class 2 equipment (also known as double insulated) does **NOT** use an earth wire and will have the following symbol on it.

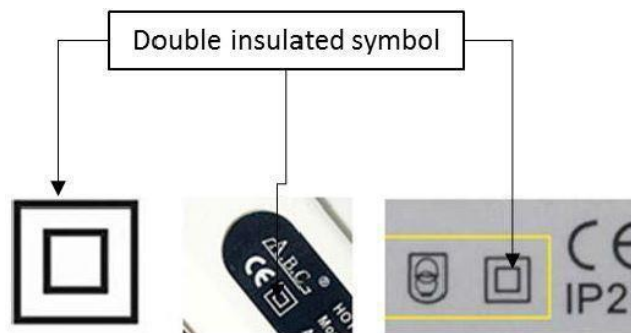

- 2.15 If the generator is to be used in a more permanent location, then it is advisable to connect the generator to an earth rod or earth point.
DO NOT put an earth rod into the ground until you have checked that it is safe to do so.
We strongly suggest that you contact a qualified electrician to assist you with this.

4. STARTING THE ENGINE



WARNING

NEVER start or stop engine with electrical devices plugged into the power outlets and devices turned on.

Unplug all electrical loads from the units power outlets or make sure that the main breaker is in the **OFF** (down) position before starting the engine.



WARNING

To avoid carbon monoxide poisoning **DO NOT** use Petrol/Diesel powered equipment inside any of the following; Home, garage, tent, camper van, mobile home, caravan or boat. This is not exhaustive and if you are in any doubt contact your dealer.

RECOIL START

- 3.0 Turn the fuel switch (1) to the 'ON' position.
- 3.1 Turn the engine switch to the 'ON' position.



- 3.2 Pull the choke knob (3) fully out.
NOTE: if starting from warm, do not use the choke.
- 3.3 Slowly pull the recoil starter handle (4) until you feel resistance.
- 3.4 Once you feel resistance, pull the recoil starter handle swiftly until the generator starts.
- 3.5 Slowly return the recoil starter handle. **DO NOT** let go of it allowing it to snap back into the starter housing.
- 3.6 Allow the generator to warm up for 20 seconds then push the choke knob back to the run position.



NOTE

When the engine switch is turned to the 'Start' position, the generator enters standby mode. If the generator is not started within 15 minutes, the standby mode will close. In this case you will need to turn the engine switch to the 'STOP' position, then turn to the run position.

ELECTRIC START

- 3.7 Turn the fuel switch (1) to the 'ON' position.
- 3.8 Turn the engine switch (2) to the 'ON' position.



- 3.9 Pull the choke knob (3) fully out.
NOTE: if starting from warm, do not use the choke.
- 3.10 With the power switch in the 'RUN' position, rotate the ignition switch (4) to 'START' and hold there for 1 second or until the engine starts.
- 3.11 Release the switch back to the 'RUN' position.

5. STOPPING THE MACHINE



CAUTION

Switch off all loads and unplug them from the generator outlet sockets.
NEVER start or stop the engine with electrical devices plugged in and turned on.
Switch the main breaker **OFF** (down).

- 4.0 Switch off all electrical loads and disconnect them.
- 4.1 Allow the engine to idle with no load, for 20 to 30 seconds.
- 4.2 Turn the engine switch to the 'OFF' position.
- 4.3 Turn the fuel switch to the 'OFF' position.

6. USING THE MACHINE



WARNING

Exhaust system heat and/or gasses could ignite combustible structures or damage the fuel tank causing a fire resulting in property damage, serious injury or death.
Contact with the exhaust area could cause burn, resulting in serious injury.

DO NOT touch hot parts and **AVOID** hot exhaust gasses.
You **MUST** allow the equipment to cool before touching.

Keep at least 5 feet (152cm) of clearance on all sides of the generator including overhead.



IMPORTANT

DO NOT overload the generator. **DO NOT** overload individual output sockets. The outlet sockets are protected against overload with a push-to-reset type of circuit breakers.

If the current rating of any circuit breaker is exceeded, that breaker will open and the electrical output to that socket will be lost.



NOTE

Connect all electrical loads in the **OFF** position then turn **ON** for operation. Turn all electrical loads **OFF** and disconnect from the generator before stopping the generator.

Exceeding the generators wattage/current capacity could damage the generator and/or the electrical devices connected to it.

DO NOT exceed the generators wattage/current capacity.

Failure to disconnect the electrical load before switching the generator OFF may damage the AVR.

- 5.0 Connecting electrical loads.
- 5.1 Let the engine run until the rpm is stable and has been allowed to warm up for a few minutes after starting.
- 5.2 Make sure the output indicator light is on (green).

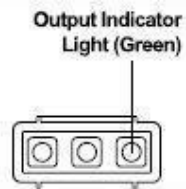

- 5.3 Plug in and turn on the electrical loads.
- 5.4 Add up the rated watts (or amps) of all loads to be connected at one time. This total should be no greater than;
 - The circuit breaker rating of the output socket supplying the power
 - or
 - The rated wattage/current capacity of the generator.
- 5.5 Overloading a generator in excess of its rated wattage capacity can result in damage to the generator and to the connected electrical devices.
- 5.6 If the overload indicator light is red, disconnect the electrical appliances and press the reset button.

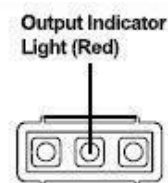

5.7 Once the overload indicator light switches off, you can reconnect the electrical appliances.

5.8 Observe the following to prevent overloading of the unit;

Add up the total wattage of all electrical devices to be connected at one time. This total should NOT be greater than the generators wattage capacity.

The rated wattage of lights can be taken from light bulbs.

The rated wattage of tools, appliances and motors can usually be found on a data label or decal affixed to the devices.

If the appliance, tool or motor does not give wattage, multiply volts x ampere rating to determine watts.

(volts x amps = watts)

5.9 Some electrical induction motors require about three times more power for starting than for running.

This surge of power only lasts a few seconds when starting.

You MUST make sure you allow for high starting wattage when selecting electrical devices to connect to the generator.

5.10 Calculate the watts needed to start the largest motor.

5.11 Add to that figure the running watts of all other connected loads.

5.12 Start the largest motor first and only one motor at a time.

5.13 The engine is equipped with a low oil level sensor that shuts down the engine automatically when the oil level drops below a specific level.



5.14 If the engine shuts down by itself and the fuel tank has enough petrol, check the engine oil level. Engine oil level should be checked daily.

5.15 To remain emissions compliant at high altitude (altitudes over 5,000 feet or 1524 meters) adjustment is required. This adjustment will cause decreased performance, increased fuel consumption and increased emissions.

Contact your dealer for high altitude adjustment information.

5.16 Operation of the engine at altitudes below 2,500 feet or 762 meters with the high altitude kit is not recommended.

5.17 The DC socket is only used for charging a 12V battery.

- 5.18 Turn the economy switch to the **OFF** position.
- 5.19 In order to avoid producing a spark, connect the charging cables to the battery terminals first and then to the generator.
Reverse this procedure when disconnecting.
- 5.20 Connect the positive battery terminal to the positive charging cable.
DO NOT reverse the charging cable as this could damage the generator or battery.
- 5.21 Before connecting the charger to a battery that is installed in a vehicle, the negative battery cable must be disconnected first.
This will prevent sparks or a short circuit if the cable accidentally contacts the vehicles body.
- 5.22 **DO NOT** start the vehicle with the battery charger connected to the battery, otherwise the generator will be damaged.
- 5.23 A battery can release explosive gasses.
Keep the battery away from any sources of ignition.
- 5.24 Charge the battery in a well ventilated area.
- 5.25 Battery electrolyte contains sulphuric acid that can cause severe burns to the skin or eyes.
The correct Personal Protective Equipment (PPE) **MUST** be worn when handling batteries.
- 5.26 If battery electrolyte gets on to the skin or eyes, rinse thoroughly with warm water for at least 15 minutes and call a Doctor immediately.
- 5.27 If you swallow any battery electrolyte, rinse your mouth with water and drink plenty of water or milk (with magnesia or vegetable oil) and call a Doctor immediately.
- 5.28 The DC socket can be used while the AC socket is in use.
- 5.29 If you use both at the same time, be sure not to exceed the total power for AC & DC.
- 5.30 If the DC circuit overloads it will trip the DC circuit protector.
To reset, remove the load first and then reset the trip switch after a few minutes.

ECONOMY SWITCH

- 5.31 With the engine Economy Switch turned 'ON', the generator automatically determines the required engine speed based on the generator load.
- 5.32 This results in much better fuel economy and reduces noise levels.
- 5.33 With the Economy Switch turned 'OFF', the engine will run at the rated speed of 3600rpm.
- 5.34 The Economy Switch must be turned off when starting devices that require a large starting current, such as air compressors.

7. MAINTENANCE



WARNING

Before cleaning, inspecting or repairing your unit, you **MUST** make sure that the engine has stopped and allowed to cool.
You **MUST** disconnect the spark plug HT lead cap to prevent any accidental starting.



CAUTION

ALWAYS refuel in a well-ventilated area with the engine off and the spark plug HT cap removed.

Whilst carrying out maintenance you **MUST** wear appropriate Personal Protective Equipment (PPE). Suggested PPE Sturdy footwear, work gloves, long trousers and hearing protection.



NOTE

Spare parts – If a part needs replacement, you **MUST** only use parts that meet the manufacturer's part number specifications.

Replacement parts that **DO NOT** meet specifications may result in a safety hazard or poor operation of the generator and will **VOID** the warranty.

Major servicing including installation or replacement parts, should be made by a qualified service technician.

Item	Maintenance	Every Usage	1 st month or 20 hours	Every 3 months or 50 hours	Every 6 months or 100 hours	Every 12 month or 200 hours
Engine Oil	Check Level	X				
	Change		X		X	
Air Filter	Check	X				
	Clean			X*		
Spark Plug	Check/Adjust				X	
	Replace					X
Valve Clearance	Check/Adjust					X**
Combustion Chamber	Clean	After every 300 hrs**				
Fuel Tank & Filter	Clean				X**	
Fuel Line	Clean	Every 2 years, replace if necessary**				

* Service more frequently in dusty environments.

** Work to be carried out by a qualified engineer or your service dealer.

AIR FILTER



CAUTION

The engine **MUST NOT** be run without an air filter otherwise piston and/or cylinder damage can occur.

This type of damage will **NOT** be covered under warranty.

Maintaining the air filter is very important.

If dirt is allowed to get in to the engine through improperly installed, serviced or inadequate filter elements, it can damage and wear out the engine.

ALWAYS keep the filter element clean.

- 6.0 Remove the air filter cover screws.
- 6.1 Remove the air filter cover.
- 6.2 Remove the air filter element and ensure no dirt or debris enters the carburetor.
- 6.3 To clean the air filter, wash in warm soapy water and allow to dry.
- 6.4 Once dry, soak in clean engine oil then squeeze to remove the excess.
- 6.5 Reinstall the air filter and air filter cover.

OIL



NOTE

Oil capacity: 600ml

Semi-Synthetic SAE15W-40 Engine oil.

- 6.6 Remove the oil filler cap/dipstick (1).
- 6.7 Unscrew the oil drain plug (2) and drain the oil in to a suitable container.

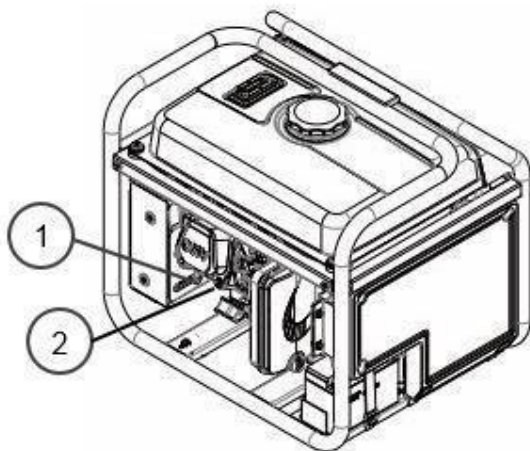

Engine Oil
Capacity:
600ml

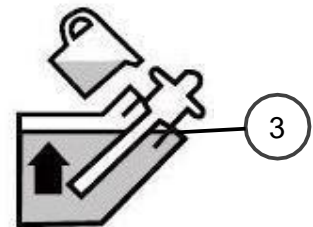

- 6.8 Replace the oil drain plug and tighten securely.
- 6.9 Slowly fill with 600ml of semi-synthetic SAE 15W40 engine oil. Stop occasionally to check the level.

- 6.10 Fill to the upper limit on the oil filler neck (3).
- 6.11 If you overfill with oil, you can drain the excess by removing the oil drain plug (3).
- 6.12 Once the correct oil level has been reached. Refit the oil filler cap/dipstick securely.

SPARK PLUG

- 6.13 Always replace with the same model spark plug, recommended spark plug for this generator is an **NGK BP7ES** or equivalent.
- 6.14 Remove the spark plug maintenance cover.
- 6.15 Carefully remove the spark plug HT lead cap.
- 6.16 Remove the spark plug using the box spanner provided in an anti-clockwise direction.
- 6.17 Check the spark plug for visible damage and electrode erosion.
- 6.18 If damaged you **MUST** replace the spark plug.
- 6.19 Remove carbon deposits from the spark plug using a soft wire brush.
- 6.20 The spark plug gap should be 0.6 – 0.7mm.
Check the gap using a feeler gauge and adjust as necessary by carefully bending the side electrode to achieve the correct gap.

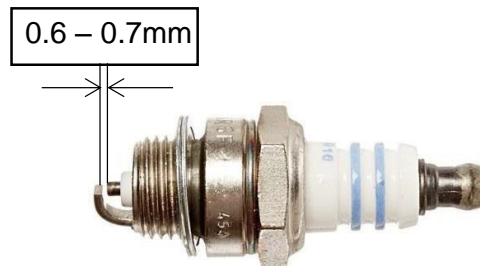

- 6.21 Refit the cleaned and adjusted spark plug by hand to avoid cross-threading.
- 6.22 After spark plug seats then tighten as necessary but avoid over-tightening.
- 6.23 Re-attach the spark plug HT lead cap and spark plug maintenance cover.

SPARK ARRESTOR

- 6.24 The spark arrestor **MUST** be maintained every 100 hours of use.
- 6.25 Remove the screws and remove the exhaust guard.
- 6.26 Remove the spark arrestor from the exhaust.
- 6.27 Remove carbon deposits from the spark arrestor by using a soft wire brush.
If the spark arrestor shows signs of wear, it **MUST** be replaced.
- 6.28 Reinstall the spark arrestor and the exhaust guard.

8. TRANSPORT & STORAGE

TRANSPORT

- 7.0 For transport, do not overfill the fuel tank.
- 7.1 If the generator has been used, allow it to cool for at least 15 minutes before loading it in to the transport vehicle.
- 7.2 To prevent fuel spillage, the generator should be secured upright in its normal working position with the start switch in the **OFF** position and the fuel cap vent lever in the **OFF** position.
- 7.3 If transporting over rough terrain, remove all the fuel from the fuel tank.
- 7.4 **DO NOT** drop or strike the generator when transporting.
- 7.5 **DO NOT** place heavy objects on top of the generator.

STORAGE

- 7.6 The following steps should be taken if you store the generator for more than 30 days.
- 7.7 Drain all the fuel from the fuel tank into a suitable container.
- 7.8 Remove the maintenance cover to gain access to the carburetor.
- 7.9 Turn the engine switch to the 'ON' position and loosen the carburetor drain screw to allow the fuel in the carburetor to drain into a suitable container.
- 7.10 Remove the spark plug HT lead cap and pull the recoil starter handle three to four times to remove all the fuel from the fuel lines.
- 7.11 Turn the engine switch to the 'OFF' position and tighten the carburetor drain plug screw.
- 7.12 Change the engine oil following the procedure 6.14 to 6.20.
- 7.13 Remove the spark plug and pour a tablespoon of fresh engine oil down the cylinder bore.
- 7.14 Pull the recoil starter handle three to four times to distribute the oil along the cylinder bore, then refit the spark plug.
- 7.15 Store in a dry place away from sources of ignition.
- 7.16 Do not stack items on top of the generator.

9. TROUBLESHOOTING

	Problem	Recommended Action
Engine will not start	Not enough fuel	Fill with fuel
	Start switch and fuel valve not ON	Turn them to the ON position
	Not enough engine oil	Add more oil
	No fuel in the carburetor	Start a few times to ensure fuel enters the carburetor
	Spark plug not working	Replace spark plug
Take to authorised dealer		
Connected device will not start	Both the output indicator and overload indicator lights are not ON	Send the generator to an authorised dealer
	If the output indicator light is ON but the device doesn't work after plugging in directly	Restart if the overload indicator light is off, if it doesn't work, send to an authorised dealer.
	Both the output indicator light and the overload indicator light are ON but device has no defects	Send the generator to an authorised dealer
If there is no power in the DC outlet	Electric circuit breaker is not intact	Replace the electric circuit breaker
	Electric circuit breaker is intact	Send the generator to an authorised dealer
Erratic DC output	Dirty air filter	Clean or replace the air filter
	Fouled petrol	Replace petrol
		Send to an authorised dealer

10. SPECIFICATION

ENGINE	Model	
	Type	4 stroke OHV single cylinder
	Displacement	212cc
	Bore/Stroke	70mm/54mm
	Compression Ratio	8.5:1
	Rated Power	4.0/3600 kW/min
	Ignition System	Full transistor
	Starting Method	Recoil / Electric
	Fuel Type	Unleaded petrol
	Oil Capacity	600ml
	Oil Type	Semi-synthetic SAE 15W-40
	GENERATOR	Model
Rated Frequency		50Hz
Rated Voltage		240V
Rated Current		12.5A
Rated Speed		3600rpm
Rated Output Power		3.0kVA
Max Output Power		3.3kVA
GENERATOR SET	DC Output	12V/5A
	Fuel Tank Volume	12.5L
	Net Weight	35kG
	Working Ambient Temperature	-15 to 40°C
	Max Altitude	1000m
	Noise Level	74 dBA @ 7m
	Dimensions LxWxH	425 x 455 x 530mm

11. RECYCLING & PRODUCT DISPOSAL

- 8.0 We do not offer a takeback scheme for the recovery of Waste Electrical Electronic Equipment (WEEE) & Batteries.
Instead the responsibility to dispose of WEEE and or Batteries is passed onto you by us.
So when it becomes necessary to dispose of your machine you must take it to your local Civic Amenity Site.
For further information please contact your local Authority for disposal advice.
- 8.1 You **MUST** make sure that all unused oil and fuel is disposed of correctly either beforehand or at your local Civic Amenity Site.
Under NO circumstances must any fuel or oil be put down any drains.
- 8.2 Certain products contain WEEE waste which should not be disposed of in your domestic waste.
- 8.3 You **MUST** recycle WEEE in accordance with your local authority or recycling centre.
- 8.4 Certain products contain batteries which should not be disposed of in your domestic waste.
- 8.5 You **MUST** recycle batteries in accordance with your local authority or recycling centre.
- 8.6 Unwanted packaging and materials should be stored and taken to a recycling centre so it can be disposed of in a manner which is compatible with the environment.
- 8.7 The following symbol means that you should 'Reduce – Reuse – Recycle'.
- 8.8 We are a Member of the VALPAK National Compliance Scheme and our registration number is **RM08660**
- 8.9 For further information about disposal please contact your Local Authority.
- 8.10 You can also get more advice and guidance about recycling at the following website <http://www.recycle-more.co.uk>
- 8.11 Should you pass this product on to another user either sold or loaned, you **MUST** pass on this user manual.
This will make sure that all other users can use and maintain this machine safely.

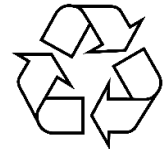

12. DECLARATION OF CONFORMITY

Genpower Ltd confirms that this Hyundai generator conforms to the following CE directives:

2006/42/EC Machinery Directive

2004/108/EC EMC Directive

2000/14/EC Noise Emissions Directive

97/68/EC NRMM Emissions Directive

13. CONTACT DETAILS

9.0 POSTAL ADDRESS	Genpower Ltd, Isaac Way, London Road, Pembroke Dock, Pembrokeshire. SA72 4RW. UK.
9.1 TELEPHONE	+44 (0) 1646 687880
9.2 FAX	+44 (0) 0164 686198
9.3 WEBSITE	www.hyundaipowerequipment.co.uk

14. MANUAL UPDATES

- 10.0 Our manuals are constantly being reviewed and updated. However if you find an error, omission or something you find unclear, please contact your dealer for assistance.
- 10.1 Our latest manuals are also placed online.
- 10.2 We reserve the right to make any modifications without prior notice whenever necessary.

15. WARRANTY

- 11.0 To register your machine for the manufacturer's warranty, please visit:
<http://www.hyundaipowerequipment.co.uk/warranty>

HYUNDAI
POWER PRODUCTS

For Inquiries, Please Contact:

GENPOWER LTD

Isaac Way, London Road

Pembroke Dock, UNITED KINGDOM, SA72 4RW

T: +44 (0) 1646 687 880 F: +44 (0) 1646 686 198

E: info@hyundaipowerequipment.co.uk

www.hyundaipowerequipment.co.uk

Imported/Distributed by GENPOWER LTD

Licensed by Hyundai Corporation, Korea